

# FX-HM SERIES

# POSITION TRANSDUCER

# INSTALLATION GUIDE

## DIMENSIONAL INFORMATION

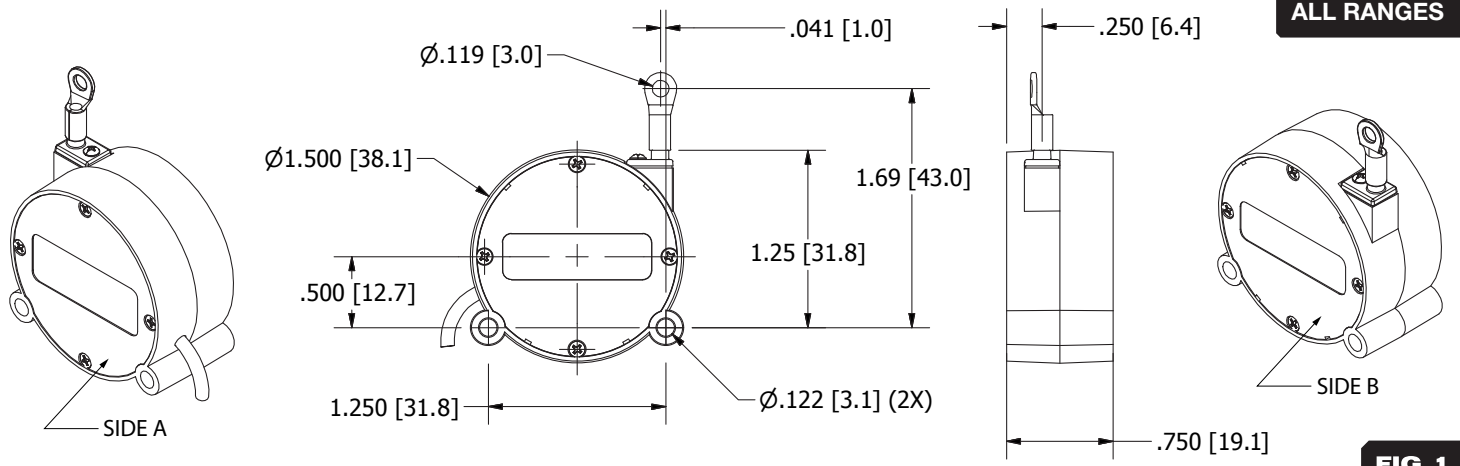

Dimensions in brackets are millimeters.

FIG 1

### SPECIFICATIONS

Output Voltage .....0 to 9.9±0.1 VDC  
 Excitation Voltage .....4.9 to 30 VDC  
 Excitation Current .....30 mA Max.  
 Output Impedance .....10Ω Max.  
 Output Load .....10KΩ Min.  
 Protection.....Reversed Polarity  
 Linearity.....±1.0% of Full Scale  
 Repeatability .....±0.03% of Full Scale  
 Nominal Resolution.....0.024% of Measurement Range  
 Operating Temperature ....-25°C to 75°C

### MOUNTING

**1** To maximize wire rope life, align transducer with moving element so that wire rope exits perpendicular to axis of wire rope exit hole within 2° (See FIG 2).

**2** Transducer may be mounted on either side A or side B (See FIG. 1) as shown Mount unit with two #4 or two M3 pan head machine screws. Place flat washers under the head of each screw. Tighten screws to 45 oz-in (.32 N-m) maximum.

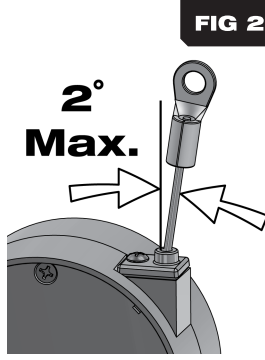

### CONNECTORS

#### CONNECTOR OPTION "C" INCLUDES:

- CABLE TO CABLE CONNECTOR
- MATING CONNECTOR

#### CONNECTOR OPTION "K" INCLUDES:

- CABLE TO CABLE CONNECTOR ONLY

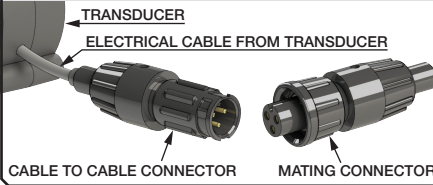

### ELECTRICAL CABLE WIRING

#### CONNECTOR OPTION "N":

- NO CONNECTORS INCLUDED

#### ELECTRICAL CABLE ATTACHED TO TRANSDUCER

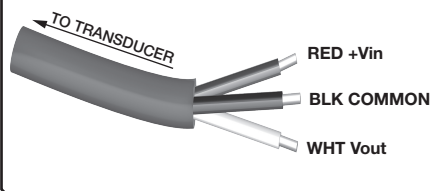

### CABLE TO CABLE CONNECTOR

#### IF ORDERED THIS CONNECTOR IS ATTACHED BY UNIMEASURE

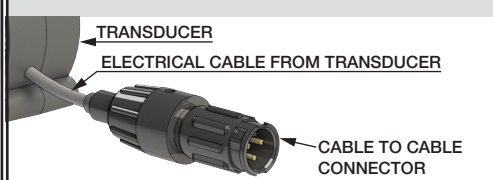

### CABLE TO CABLE CONNECTION DIAGRAM

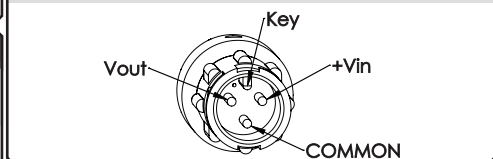

### MATING CONNECTOR

#### THIS CONNECTOR REQUIRES ASSEMBLY

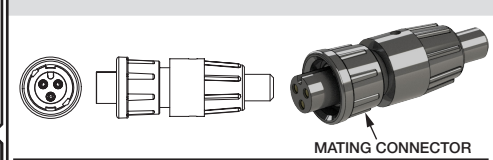

### MATING CONNECTOR WIRING DIAGRAM

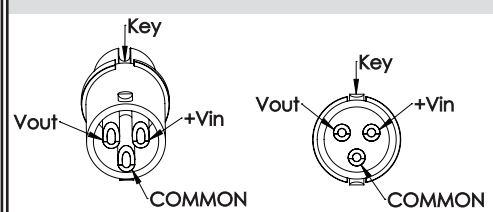

### ADDITIONAL INFORMATION

All measurement ranges of model FX-HM are equipped with wire rope that will extend slightly beyond 15" (381mm). Typically the primary usable range is considered to be the initial travel with the eye fitting just off of its home position. However with several of the shorter ranges, the wire rope may be extended through the first range and then repeated with further extension.

No adjustment of the output is available on the transducer. With the eye fitting resting on the wire rope guide the output voltage will be slightly negative. Extraction of the wire rope will increase the output voltage to the zero position. This will usually happen within the first .040" (1mm) of wire rope travel. The official wire rope travel range begins when the voltage output reaches the zero point. From this point extending the wire rope to the full length of the designated measurement range for the transducer will result in an output voltage between 9.8 and 10.0 VDC.

#### NOTE:

A warm up period for the electronics of approximately 5 minutes should be allowed.

Model FX-HM employs a hall effect device which produces an output signal that is proportional to the field strength of an internal magnet. Thus the presence of an external magnet with field strength of 1 mT or greater measured on the side of the unit opposite the wire rope exit can have a minor effect on the output of the unit. The output may shift by several millivolts. As long as the magnet is stationary the linearity of the unit will not be affected with magnetic field strengths up to 6 mT. However, if the magnet moves (ie. a fluctuating external magnetic field), a fluctuation in the electrical output will also be noticed. For best results, model FX-HM should be used in the absence of external magnets. As a side note, the FX-HM is not affected by the presence of ferrous material.

FOR SENSITIVITY INFORMATION, SEE OPPOSITE S

**um UniMeasure**

**Herbertek** www.herbertek.se  
 info@herbertek.se  
 +46-18 590510