

P510 SERIES

0 to 5, 0 to 10, ±5, ±10 VDC ANALOG OUTPUT



The UniMeasure P510 Series transducer offers a voltage output with wide adjustability to give a 0 to 5, 0 to 10, ±5 or ±10 VDC output. The device may be powered with an unregulated voltage in the range of 4.9 to 30 VDC. Zero and span adjustment potentiometers are readily accessible. With the zero position set anywhere within the first 30% of total travel, the span may be adjusted to give a full 0 to 5 or 0 to 10 VDC output with the span set anywhere within the last 20% of travel. Alternatively, the zero position may be set anywhere between 10% and 90% of full travel to give an output of ±5 or ±10 VDC with the span set between 50% to 100% of the longest travel from the zero position.

SPECIFICATIONS

GENERAL

Linearity	
2", 3", 4" & 5" Ranges	±0.30% Full Scale
10", 15", 20" & 25" Ranges	±0.20% Full Scale
All other ranges	±0.15% Full Scale
Repeatability ^[1]	±0.015% Full Scale
Resolution	Essentially Infinite
Construction	Aluminum Cover & Baseplate
Sensing Device	Precision Potentiometer
Connector	MS3102A-14S-6P
Wire Rope	Ø.016 Stainless Steel
Wire Rope Tension	See Supplemental Data ^[2] , Table 7
Wire Rope Inbound Acceleration	See Supplemental Data ^[2] , Table 7
Weight	
Up to 50"	1.0 lb. (0.45 Kg)
60" & 80"	1.4 lb. (0.63 Kg)
Dimensional Information	See Supplemental Data ^[2] , Fig. 1 & 2
Options and Accessories	See Supplemental Data ^[2]

ENVIRONMENTAL

Thermal Coefficient of Sensing Element	±100 PPM/°C max.
Operating temperature	-40°C to +95°C
Operating humidity	95% R.H. max. non-condensing
Vibration	15 G's 0.1 ms max.
Shock	50 G's 0.1 ms max.
Ingress Protection	IP-40 (NEMA 1)

ELECTRICAL

Output	0 to 5 or 10 VDC, ±5 or ±10 VDC
Excitation Voltage	4.9 to 30 VDC
Excitation Current	25 mA max.
Output Impedance	10Ω max.
Output Load	5KΩ min.
ADJUSTMENT RANGE—0 TO 5 OR 0 TO 10 VDC	
Zero	0 to 30% of Range
Span	80% to 100% of Range
ADJUSTMENT RANGE—±5 OR ±10 VDC	
Zero	10% to 90% of Range
Span	50% to 100% of Longest Possible Travel from Zero Position
Protection	Reversed Polarity
Temperature Stability	0.02%/°C of Span

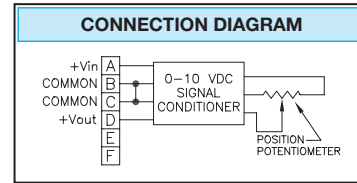

FOOTNOTES TO SPECIFICATIONS

- Moving to the same position from the same direction.
- Span may be adjusted from 5 VDC to 10 VDC within percentage of range shown.
- Supplemental Data section located at end of Standard Series pages.

MODEL NUMBER CONFIGURATION

P510- 0 - 1 2 3 - 4 5 6 - 7 8 9

BASIC CONFIGURATION (FOR ALL RANGES)

P510-50-S10-N0S-10C

0 RANGE
2.....2" (50 mm)
3.....3" (75 mm)
4.....4" (100 mm)
5.....5" (125 mm)
10.....10" (250 mm)
15.....15" (390 mm)
20.....20" (500 mm)
25.....25" (640 mm)
30.....30" (750 mm)
40.....40" (1000 mm)
50.....50" (1250 mm)
60.....60" (1500 mm)
80.....80" (2000 mm)

1 WIRE ROPE
S.....Ø.016 (0,4 mm) Stainless Steel
N.....Ø.018 (0,45 mm) Nylon Jacketed Stainless Steel

2 WIRE ROPE TENSION
1.....Standard (50 G Units to 50")
2.....Reduced (See Table 7 for Value)
3.....Increased (100G Ranges to 50")*
*Not Available Ranges 2" to 5"

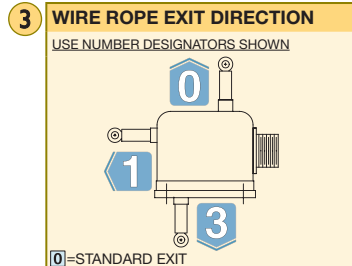

4 DUST WIPER OPTION
N.....No dust wiper
D.....Dust Wiper Included

5	0.....Required Designator
----------	---------------------------

6 ELECTRICAL OUTPUT POLARITY
S.....Standard (increasing output as wire rope is extended)
R.....Reversed (decreasing output as wire rope is extended)

7 CONNECTOR LOCATION
USE NUMBER DESIGNATORS SHOWN

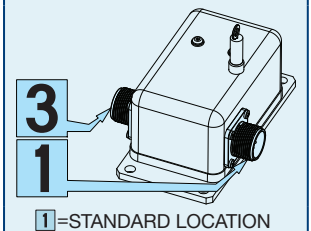

8	0.....Required Designator
----------	---------------------------

9 ELECTRICAL INTERFACE
C.....Mating Connector Included
K.....Mating Connector Omitted*
T.....Terminal Strip
*Electrical cable with mating connector may be ordered separately as part number 10028-xM where 'x' is the length required in meters.

Herbertek www.herbertek.se
info@herbertek.se
+46-18 590510

ADDITIONAL OPTIONS

TABLE 7

STANDARD SERIES — WIRE ROPE TENSION AND ACCELERATION

RANGE	PA, PB, P420, P510 SERIES					EP SERIES				V & VP SERIES			
	STANDARD WIRE ROPE TENSION	STANDARD WIRE ROPE ACCEL	REDUCED WIRE ROPE TENSION	REDUCED WIRE ROPE ACCEL		STANDARD WIRE ROPE TENSION	STANDARD WIRE ROPE ACCEL	REDUCED WIRE ROPE TENSION	REDUCED WIRE ROPE ACCEL	STANDARD WIRE ROPE TENSION	STANDARD WIRE ROPE ACCEL	REDUCED WIRE ROPE TENSION	REDUCED WIRE ROPE ACCEL
(in) (mm)	(oz) (N)	(G's)	(oz) (N)	(G's)		(oz) (N)	(G's)	(oz) (N)	(G's)	(oz) (N)	(G's)	(oz) (N)	(G's)
2 50	34 9.5	>50	16 4.4	28	–	–	–	–	–	34 9.5	33	16 4.4	14
3 75	24 6.7	>50	14 3.9	16	–	–	–	–	–	24 6.7	30	14 3.9	15
4 100	24 6.7	>50	11 3.1	12	–	–	–	–	–	24 6.7	36	11 3.1	15
5 125	34 9.5	>50	8 2.2	7	–	–	–	–	–	34 9.5	33	8 2.2	6
10 250	34 9.5	>50	16 4.4	28	34 9.5	43	16 4.4	19	19	34 9.5	33	16 4.4	14
15 390	24 6.7	>50	14 3.9	16	–	–	–	–	–	24 6.7	30	14 3.9	15
20 500	24 6.7	>50	11 3.1	12	–	–	–	–	–	24 6.7	36	11 3.1	14
25 640	34 9.5	>50	8 2.2	7	34 9.5	37	8 2.2	7	7	34 9.5	33	8 2.2	6
30 750	24 6.7	>50	14 3.9	16	–	–	–	–	–	24 6.7	30	14 3.9	15
40 1000	24 6.7	>50	11 3.1	12	–	–	–	–	–	24 6.7	36	11 3.1	12
50 1250	34 9.5	>50	8 2.2	7	34 9.5	37	8 2.2	7	7	34 9.5	33	8 2.2	5
60 1500	24 6.7	27	7 1.8	2	24 6.7	18	7 1.8	5	5	24 6.7	27	7 1.8	6
80 2000	19 5.3	16	5 1.4	2	19 5.3	7	5 1.4	2	2	19 5.3	16	5 1.4	3

Herbertek www.herbertek.se
info@herbertek.se
+46-18 590510

LIFE

Ranges 2" to 5" 5,000,000 full stroke cycles
 Ranges 10" to 25" 500,000 full stroke cycles
 Ranges 30" to 80" 250,000 full stroke cycles

*With 1K ohm potentiometer, wire rope misalignment 2° maximum at full stroke, relatively dust free environment, and with nylon jacketed wire rope

OPTION DESCRIPTIONS

OPTION	OPTION DESIGNATOR	DESCRIPTION						
Nylon jacketed wire rope	N	Replaces standard stainless steel wire rope with Ø.018 nylon jacketed wire rope. Increases wire rope life dramatically but may increase non-linearity by as much as ±0.05% of full scale.						
Reduced Wire Rope Tension	2	Reduces the overall tension in the wire rope and increases wire rope life. Dynamic response of the transducer is reduced due to the reduced inbound acceleration capability.						
Increased Wire Rope Tension	3	Increases tension in the wire rope which increases the dynamic response of the transducer. On selected units with range of 50" (1250 mm) or less, inbound acceleration capability is 100G's. Wire rope life may be adversely affected by the high tension option.						
Dust wiper	D	Lubricated wiper strips dust and debris from wire rope as it retracts into case. Adds 0.36" (9 mm) height to wire rope exit location.						
Non-standard potentiometer (applies to PA series only)	3,4	Non-standard potentiometer linearity is as follows: <table border="1" style="margin-left: 20px;"> <thead> <tr> <th>RANGE</th> <th>LINEARITY</th> </tr> </thead> <tbody> <tr> <td>10" to 25"</td> <td>±0.50% of full scale</td> </tr> <tr> <td>30" and above</td> <td>±0.25% of full scale</td> </tr> </tbody> </table> Note: This option is subject to potentiometer availability.	RANGE	LINEARITY	10" to 25"	±0.50% of full scale	30" and above	±0.25% of full scale
RANGE	LINEARITY							
10" to 25"	±0.50% of full scale							
30" and above	±0.25% of full scale							
Reversed output	R	Output is at a maximum when wire rope is fully retracted. Output decreases as wire rope is extended. Does not apply to velocity or encoder signal.						
Terminal strip	T	Replaces connector with a terminal strip.						

10067 – AUXILIARY WIRE ROPE EXTENSION KIT

The auxiliary wire rope extension may be used to facilitate mounting the transducer remotely from the measurement point. The clip on the extension attaches to the eye fitting on the transducer. The eye fitting on the opposite end, which is identical to the fitting on the transducer, mounts to the moving element. The extension kit is also available with the clip end unterminated for situations where it is more convenient to size the wire rope length during installation. Clip and crimp fitting are included with the unterminated version.

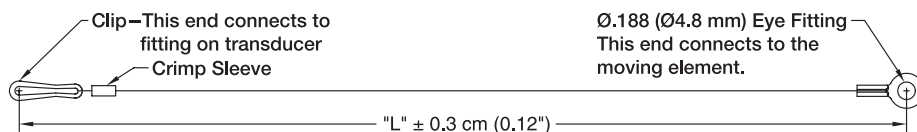

10067- 1 -CM- 2

- 1 DIMENSION "L"**
Specify Dimension "L" in centimeters to the nearest whole centimeter
NOTES: 1. 1 cm = 0.394", 1 inch = 2.54 cm
 2. Shortest length "L" is 5 cm (approximately 2")
- 2 UNTERMINATED CLIP END**
 Leave Blank.... Completed kit (No designator required)
 U Unterminated Clip End (clip and crimp sleeve included in kit)

REPLACEMENT WIRE ROPE KITS

The replacement Wire Rope Kit includes a new wire rope with all end terminations, wire rope guide, felt dust wiper where applicable and installation instructions. To order, replace 'xx' in the part number with the applicable measurement range in inches.

- 10107-xx Replacement Wire Rope Kit**—Standard Ø.016" Stainless Steel Wire Rope.
- 10108-xx Replacement Wire Rope Kit**—Ø.018" Nylon Jacketed Stainless Steel Wire Rope.
- 10127-xx Replacement Wire Rope Kit**—Standard Ø.016" Stainless Steel Wire Rope with Dust Wiper.
- 10128-xx Replacement Wire Rope Kit**—Ø.018" Nylon Jacketed Stainless Steel Wire Rope with Dust Wiper.

DIMENSIONAL INFORMATION

RANGES TO 50" (1250 MM)

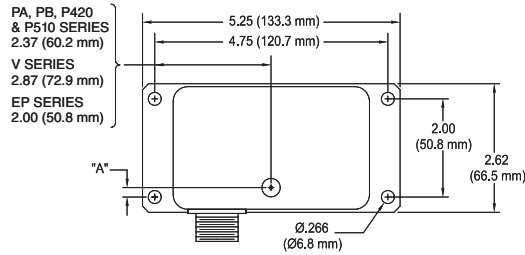
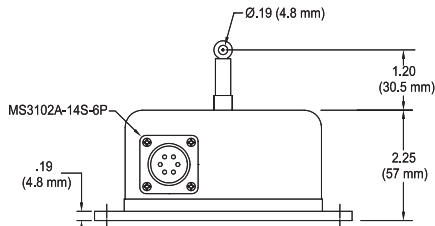

FIG. 1



PA, PB, P420, P510, V Series

RANGE	DIM "A"
	(inch) (mm)
2", 10"	0.66 (16.8)
3", 15", 30"	0.51 (12.9)
4", 20", 40"	0.35 (8.8)
5", 25", 50"	0.19 (4.8)
60"	See Fig. 2
80"	See Fig. 2

EP Series

RANGE	DIM "A"
	(inch) (mm)
EP-10	0.68 (17.4)
EP-25, EP-50	0.21 (5.3)
EP-60	See Fig. 2
EP-80	See Fig. 2
EPM-250	0.68 (17.4)
EPM-1250	0.21 (5.3)

Dimensions in brackets are millimeters

RANGES 60" (1.5 M) AND 80" (2 M)

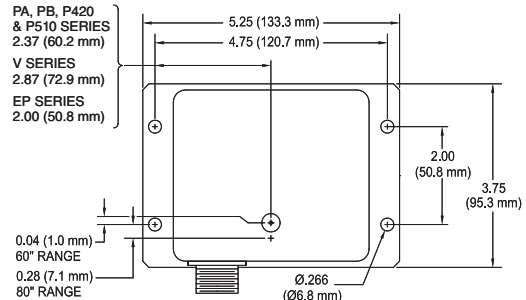
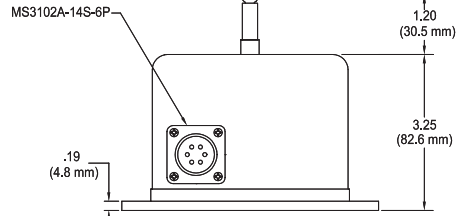

FIG. 2



Dimensions in brackets are millimeters

VP SERIES (VELOCITY/POSITION) — ALL MEASUREMENT RANGES

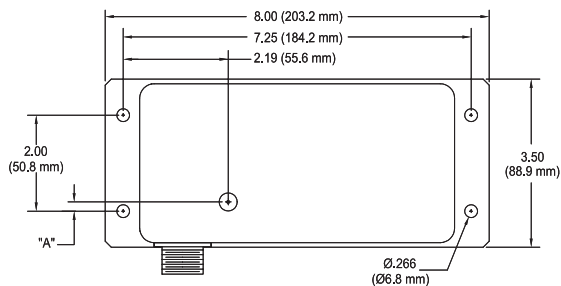
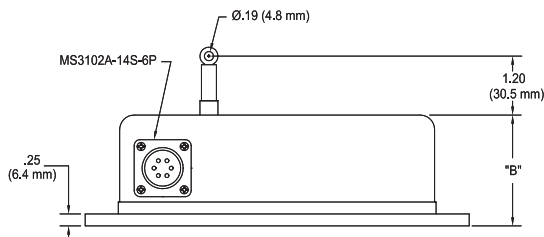

FIG. 3



Dimensions in brackets are millimeters

VP SERIES				
RANGE	DIM "A"		DIM "B"	
	(inch)	(mm)	(inch)	(mm)
2", 10"	0.66	16.8	2.25	57.0
3", 15", 30"	0.51	12.9	2.25	57.0
4", 20", 40"	0.35	8.8	2.25	57.0
5", 25", 50"	0.19	4.8	2.25	57.0
60"	0.04	1.0	3.25	82.6
80"	-0.28	-7.1	3.25	82.6