

GAIN AND OFFSET ADJUSTMENTS SEALED (CODE 'Y')

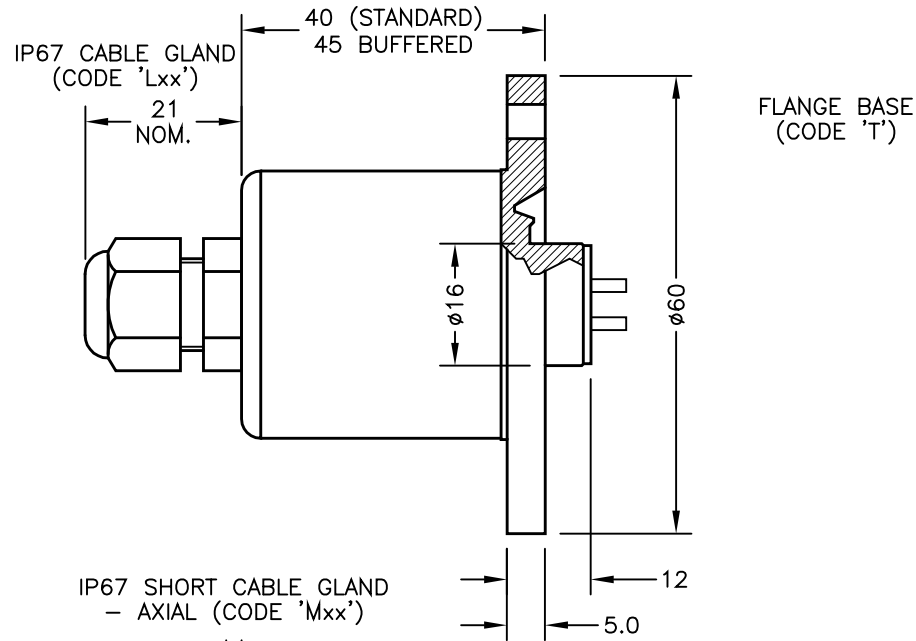

SYMMETRICAL WITH 2 OFF 4.5 SLOTS ±15° ON 48.0 PCD.

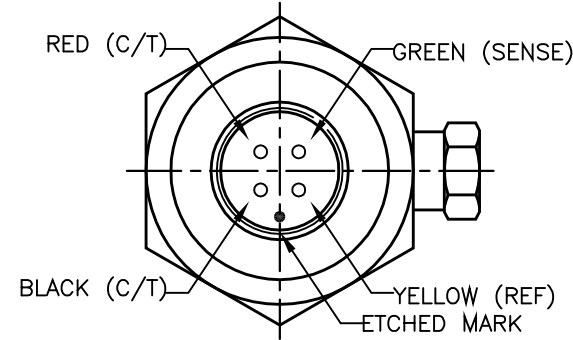
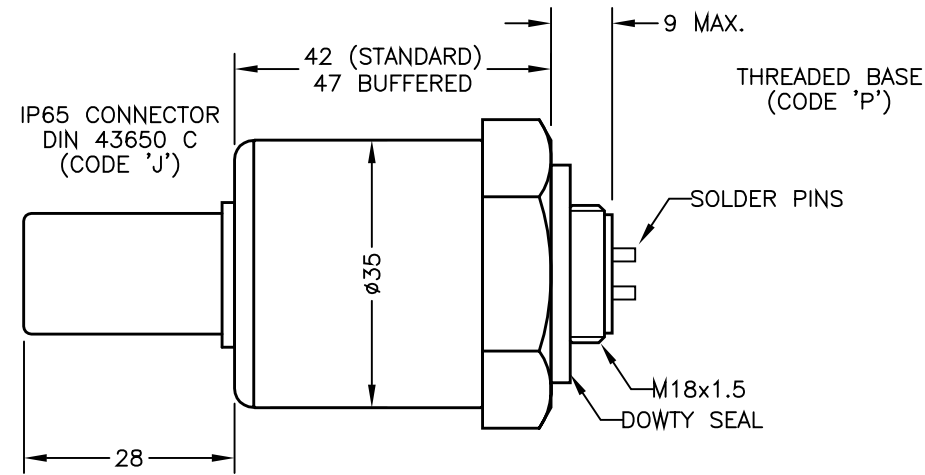
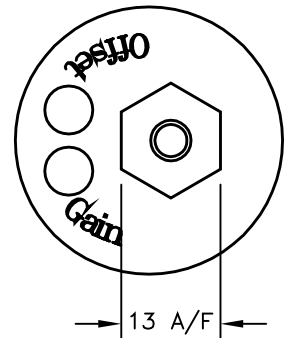
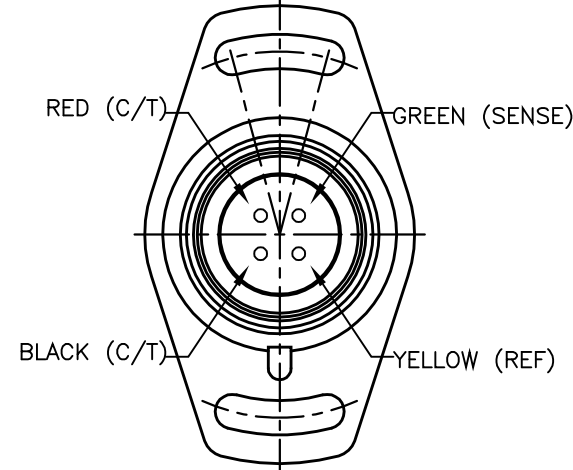

*HOUSING BORE TO SUIT PROBE: $\phi 20.10$ TO $\phi 20.15$ (§ 16.7% TO 11.4% SQUEEZE WITH 16x2.4 O-RING). RETAIN PROBE WITH GRUB SCREW.

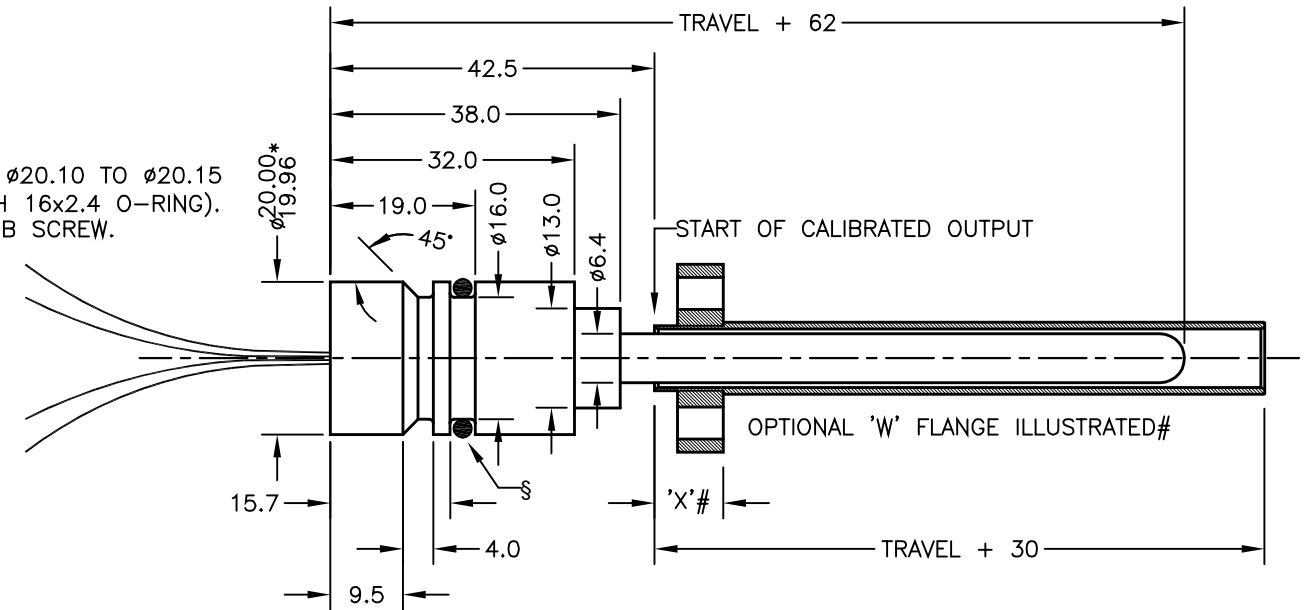
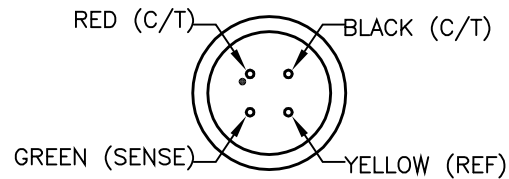

ELECTRICAL OPTIONS/ SPECIFICATIONS

	OUTPUT	SUPPLY	
A	0.5 TO 4.5V RATIO METRIC	5V	STANDARD
B	±5V	±15V	
C	0.5 TO 9.5V	24V	
D	±10V	±15V	BUFFERED
G	0.5 TO 4.5V	24V	
E	4 TO 20mA 2-WIRE	24V	
F	4 TO 20mA 3-WIRE SINK	24V	
H	4 TO 20mA 3-WIRE SOURCE	24V	

SINK VERSION OUTPUT COMPLIANCE 5-28V
SOURCE VERSION DRIVE 300Ω MAX TO 0V

CABLE: 0.2mm², O/A SCREEN, PUR JACKET - SUPPLIED WITH 50cm OR REQUIRED LENGTH IN cm. e.g. 'L50'

3-CORE: JACKET $\phi 4$ mm

4-CORE: JACKET $\phi 4.6$ mm

CABLE/CONNECTOR* CONNECTIONS;

3 CORE 4 CORE CONNECTOR

RED	RED	:1	+Ve
BLACK	GREEN	:3	0V
WHITE	YELLOW	:4	-Ve - OPTIONS: B OR D
SCREEN	BLUE	:2	OUTPUT
SCREEN	SCREEN	:4	BODY - OPTIONS: A, C, E-H

*CONNECTORS; MAXIMUM CONDUCTOR CROSS SECTION 0.75mm²
RANGE OF DISPLACEMENT FROM 0-5mm TO 0-800mm e.g.76, IN INCREMENTS OF 1mm.

BODY TUBE/PROBE HOUSING MATERIAL: STAINLESS STEEL.
35 A/F BASE MATERIAL: ALUMINIUM ALLOY (CODE 'P')
FLANGE MATERIAL: ALUMINIUM ALLOY (CODE 'T')

FURTHER OPTIONS:
SEE DRAWING TG24-11 FOR #OPTIONAL FLANGE DETAILS AND ORDERING INFORMATION.

TARGET TUBE:
STAINLESS STEEL 316 $\phi 9.45$ OPTION 'R'
ALUMINIUM 6063 $\phi 3/8$ " (9.2-9.8) OPTION 'S'
SEE P100-12 FOR DETAILS TYPICAL TARGET TUBE MOUNTING ARRANGEMENTS

CONNECTIONS BETWEEN PROBE AND ELECTRONICS MODULE: FOUR WIRES; RED, BLACK, GREEN AND YELLOW, LENGTH: 300, CROSS SECTION: 0.25mm², WIRES POTTED IN PROBE HOUSING. INTERCONNECTIONS MUST BE PROTECTED FROM WATER INGRESS AND STRAIN RELIVED.

G	ADDITIONAL DIMS/VIEWS ADDED.	PDM
H	RANGE WAS 50-600mm RAN1056	RDS
J	TARGET NOTES AMENDED ~ RAN1114	PDM
K	RANGE NOTE AMENDED ~ RAN1200	PDM



DRAWINGS NOT TO BE CHANGED WITHOUT REFERENCE TO THE CHANGE PROCEDURE. CHANGES TO PARTS USED IN INTRINSICALLY SAFE PRODUCT MUST BE APPROVED BY THE AUTHORISED PERSON
THIS IS AN UNCONTROLLED PRINT AND WILL NOT BE UPDATED.

Herbertek www.herbertek.se
info@herbertek.se
+46-18 590510

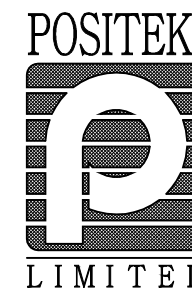

G	05/07/11		CHECKED BY	X	±0.4
H	9/11/15		RDS	X.X	±0.2
J	18/10/16			X.XX	±0.1
K	30/08/17				DIMS mm
		DESCRIPTION			
		P106 LIPS INT'NAL MOUNTED CYLINDER SENSOR WITH EXTERNAL ELECTRONICS			
SCALE		DRAWING NUMBER		REV	
10mm		P106-11		K	
		SHEET		1 OF 1	